

# GUIDE TO MAKE DIY MASKS



# HOW TO MAKE A DIY MASK



# DESIGN 1.

## What you need



2 cotton fabric rectangles, 20 cm x 16.5 cm

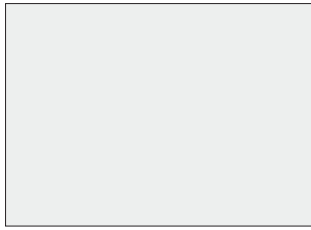

1 fusible interfacing rectangle of 20 cm x 16.5 cm

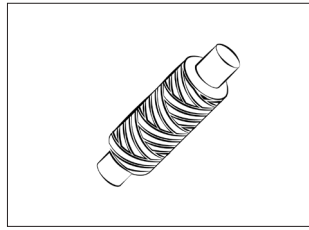

Soft elastic band

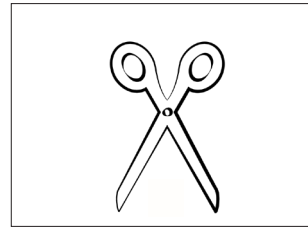

Scissors

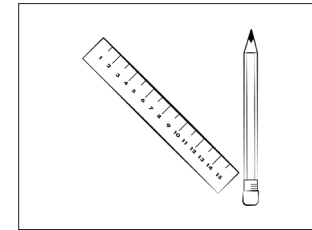

Ruler and pencil

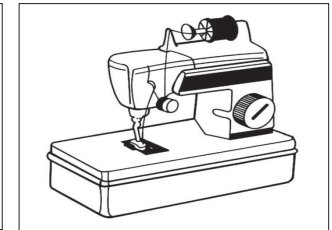

Sewing machine, needle and thread

## 1. First step

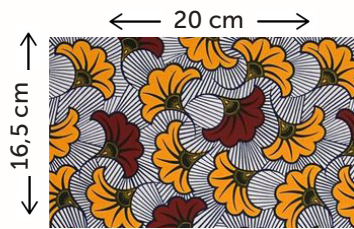

Cut 2 rectangles of 100% cotton fabric, 20 cm x 16.5 cm

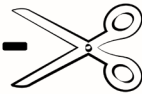

Cut 1 rectangle of interfacing of 20 cm x 16.5 cm

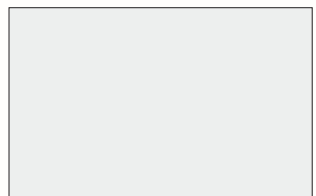

## 2. Second step



Put the three layers together: cotton + interfacing + cotton

The interfacing will **always** be in the middle

Once the three layers are together, you can iron so that the interfacing adheres to the fabrics



## 3. Third step



+

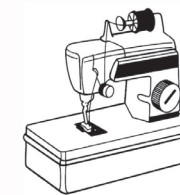

=



Sew the three overlapping layers

#### 4. Fourth step

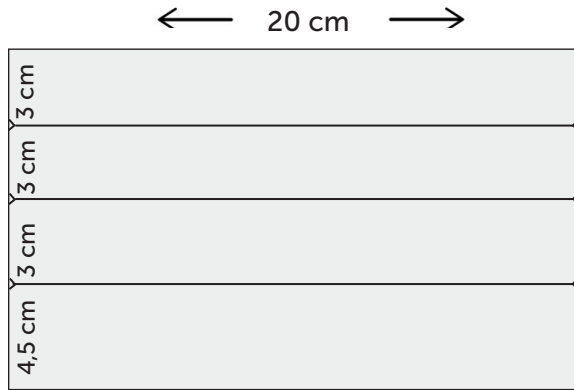

↑  
16,5 cm  
↓

Fold the fabric every 3 cm; the last fold is 4.5 cm

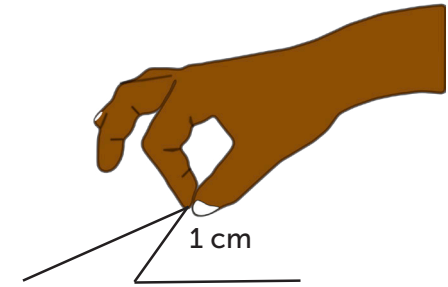

1 cm

#### 5. Fifth step

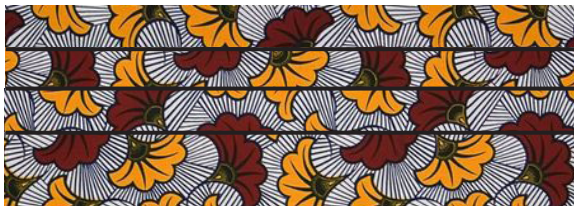

+

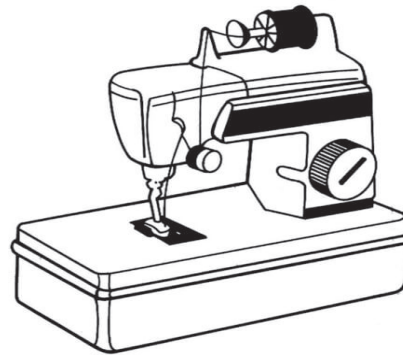

=



Sew the sides

#### 6. Sixth step

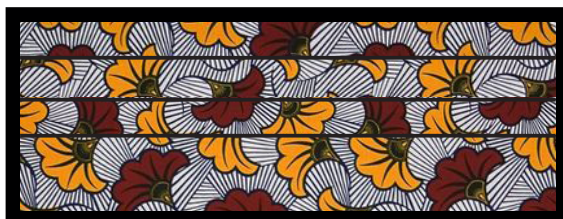

Sew the bias tape pour the entire contour

#### 7. Seventh step

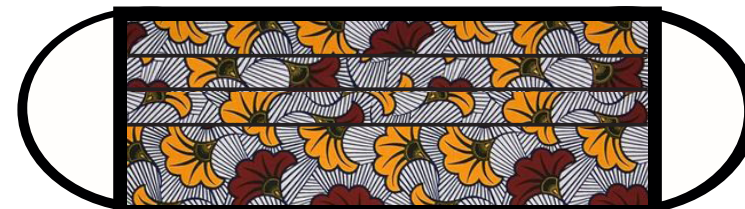

Sew a 10 cm elastic band on each side



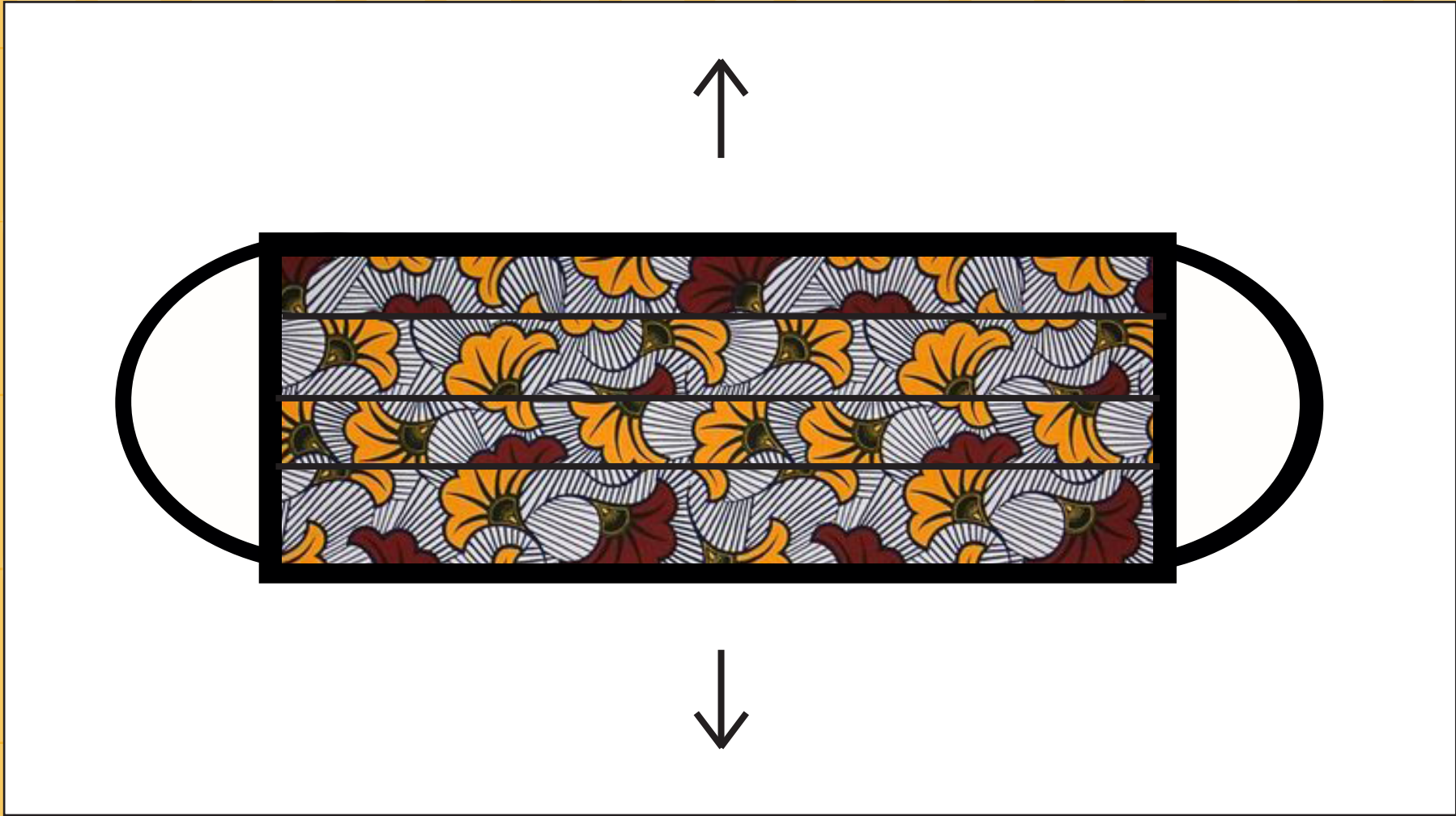



# DESIGN 2.

## What you need



2 cotton fabric rectangles, 20 cm x 16.5 cm

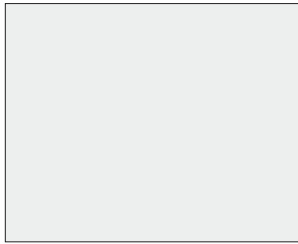

1 fusible interfacing rectangle of 20 cm x 16.5 cm



Iron

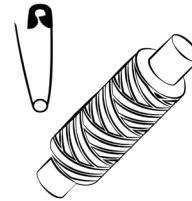

Soft elastic band and a safety pin

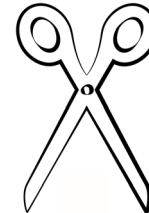

Scissors

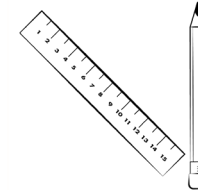

Ruler and pencil

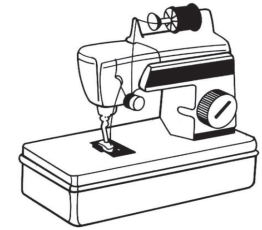

Sewing machine, needle and thread

## 1. First step

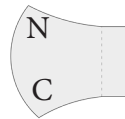
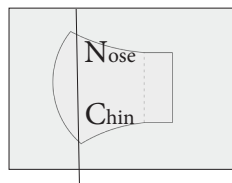
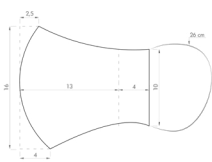

With your pen, draw the shape of the pattern on the interfacing and cut  
Or, draw as many shapes as the masks you want to make and cut at the end

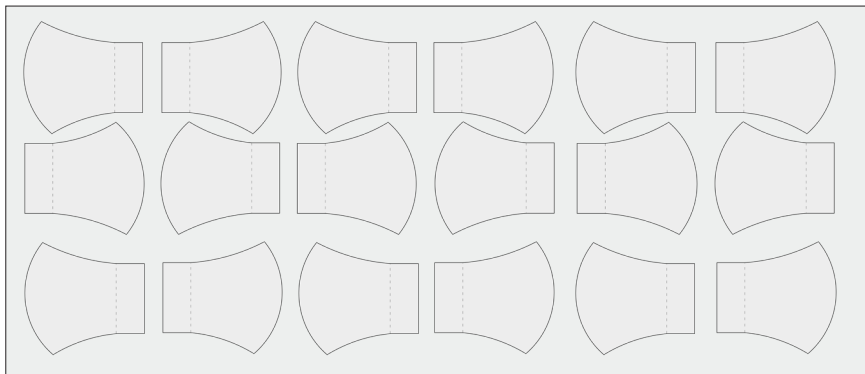

## 2. Second step

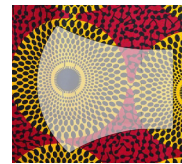

Place the interfacing on the 100% cotton fabric and iron Cut the shape on the fabric

Cut the shape on the fabric

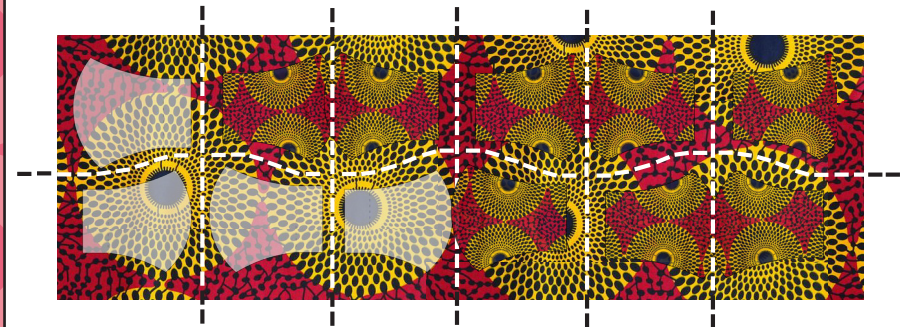
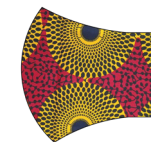



### 3. Third step

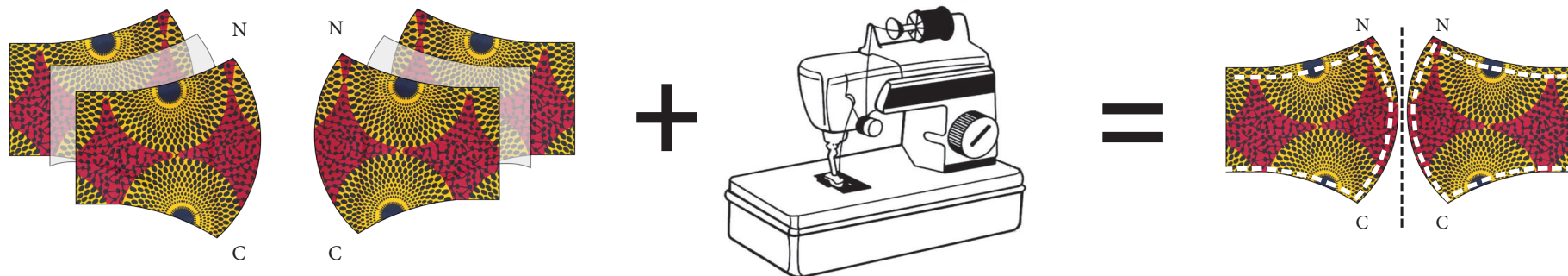

Put the three layers together: cotton + interfacing + cotton  
The interfacing will **always** be in the middle  
Sew the 3 layers and the 2 parts (left and right) of the mask

**NOTE:** The shapes are not symmetrical, the angle to cover the nose is smaller than the one for the chin, however before sewing, you must make sure that the angles fit perfectly

### 4. Fourth step

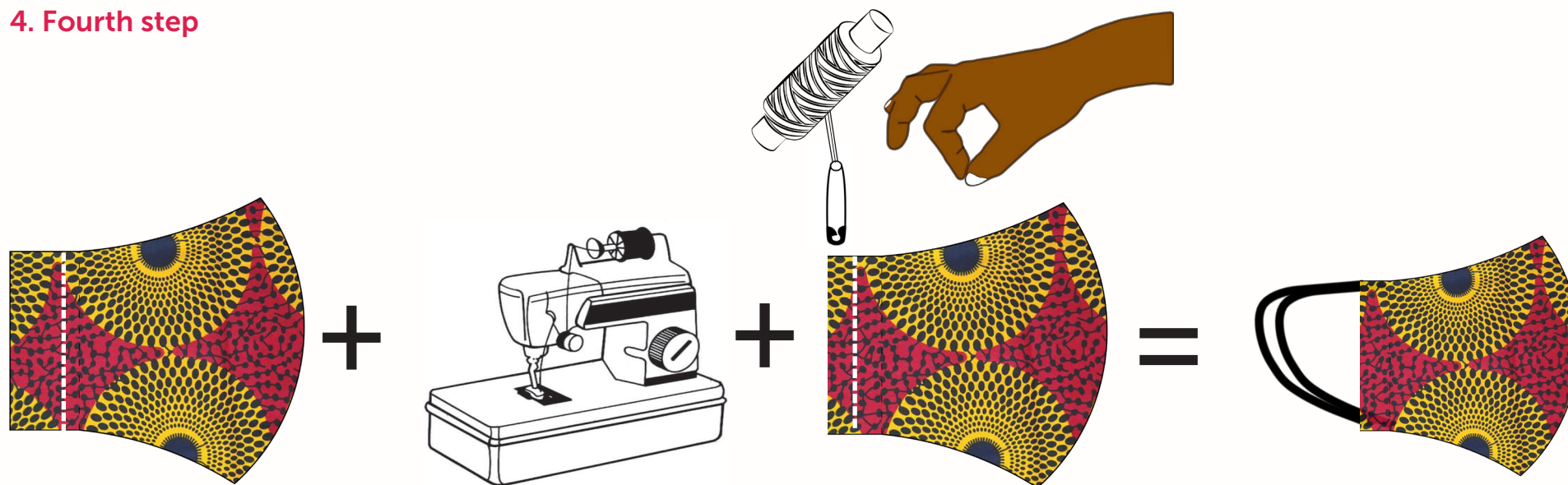

Make a 2 cm hem with space inside for the elastic band

Sew a 25 cm elastic band on each side







It is recommended to print the pattern so to be sure that all measurements are correct

